

FEATURE

- . Potentiometer-type spring return type displacement sensor
- . It is a resistance output type & Voltage output.
- . Easy to handle with compact shape

SPECIFICATION

MODEL	LPS	
Rated capacity	10, 30, 50mm	80, 100 mm
Non-linearity	± 0.3% F.S.	± 0.4% F.S.
Hysteresis	± 0.15% F.S.	± 0.1% F.S.
Non-repeatability	± 0.15% F.S.	± 0.1% F.S.
Total resistance(±15%)	2kΩ(stroke10mm)	5kΩ(stroke30~100mm)
Temperature range compensated	-10°C ~ 70°C	
Temperature range safe	0°C ~ 60°C	
Excitation Voltage	10V DC	
Cable	φ4 Shield 5m	



CIRCUIT DIAGRAM

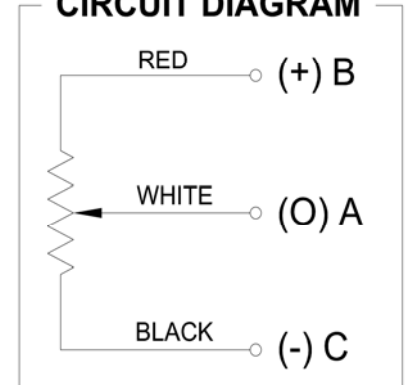

TIP TYPE

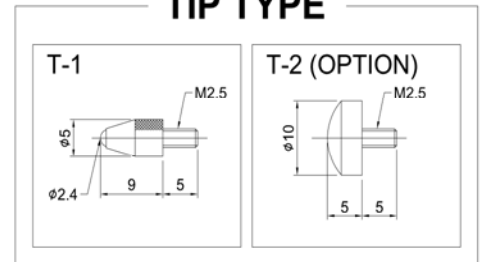

BRACKET(OPTION)

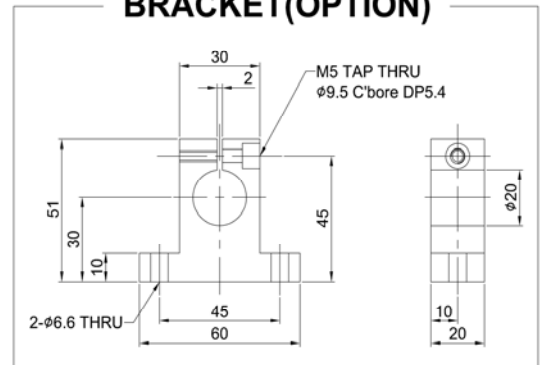

◆ SPECIAL TYPE

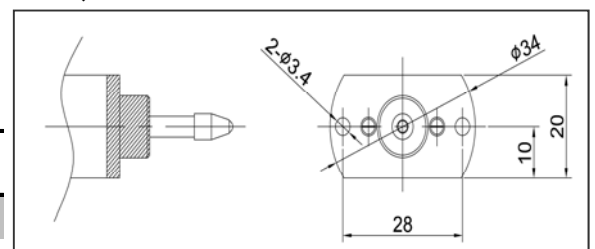

DIMENSION (mm)

Stroke	A	B	C
10 mm	83.5	63.5	Useful Stroke +0.5 / -0
30 mm	123.5	83.5	Useful Stroke +0.5 / -0
50 mm	163.5	103.5	Useful Stroke +0.5 / -0
80 mm	245	155	Useful Stroke +0.5 / -0
100 mm	265	155	Useful Stroke +0.5 / -0